

SUPPORT DE STORES UNIVERSEL GEKO

Pour coffre avec rainure en partie supérieure jusqu'à 45 mm en retrait de la face avant.



Pour coffre sans rainure, utiliser la cale GEKO.
 À n'utiliser que sur coffres PVC (pas de coffres en tôle d'acier ou d'aluminium laqué).
 Un mauvais dégraissage peut entraîner le décollement de la cale adhésive.
 À n'utiliser qu'avec la cale pour des stores e largeur maxi. 60 cm.

1 Positionner et prérégler le support

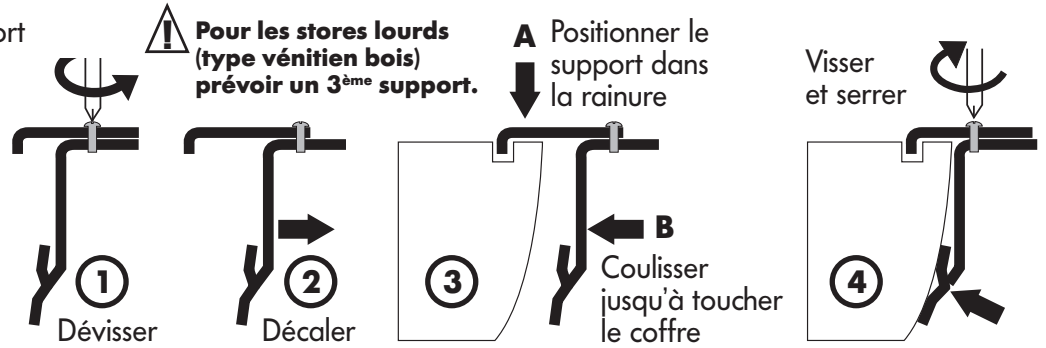
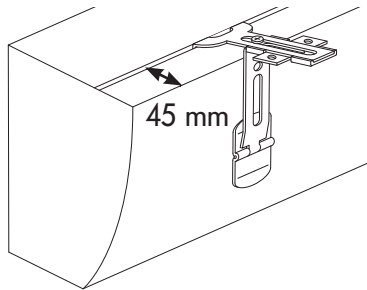

2 Fixer le support de pose fourni avec le store, sur le support Geko

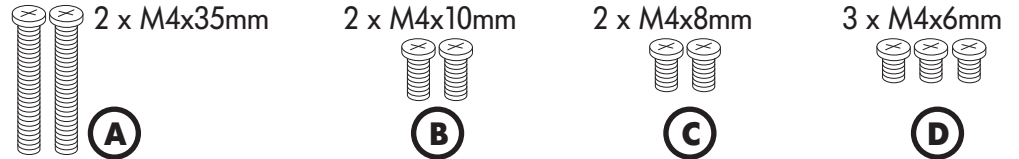

STORE ENROULEUR BOIS TISSÉ®

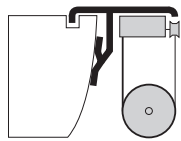

Perçer $\varnothing 5$ mm le bâton bois pour le passage des 2 vis A

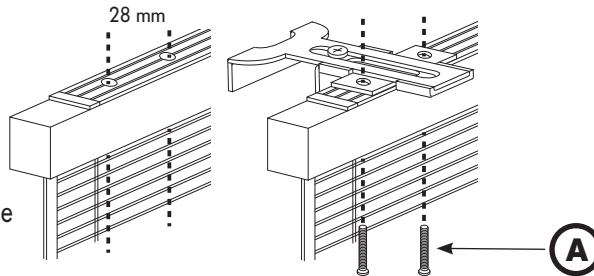

RAIL

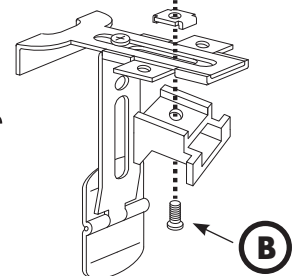
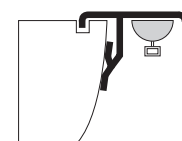

STORE VÉNITIEN

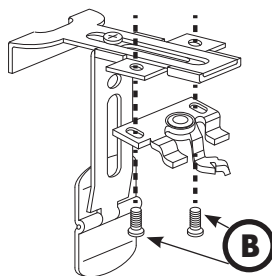
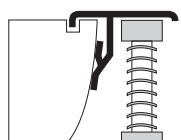

STORE BATEAU

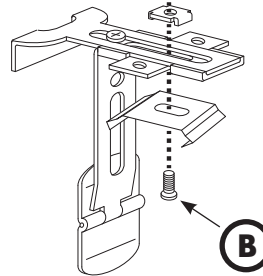
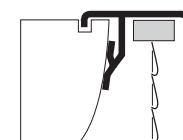

STORE ENROULEUR

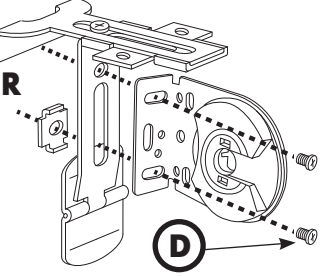
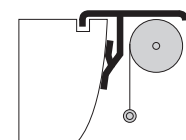

STORE ENROULEUR jour/nuit

1 / Couper la partie haute de la pièce A

2 / Emboîter la pièce B dans la pièce A

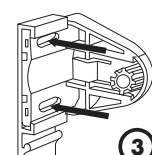
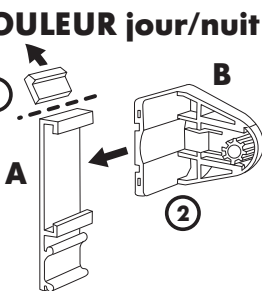

3 / Perçer la pièce A $\varnothing 5$ mm à travers les lumières de la pièce B

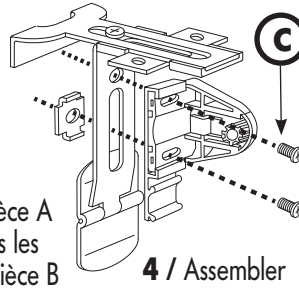

4 / Assembler

PANNEAU JAPONAIS

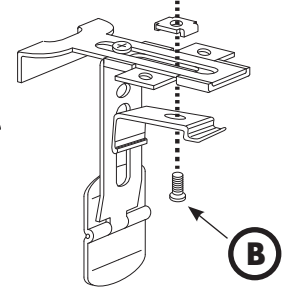
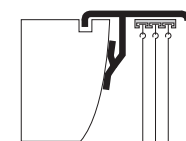

3 Retirer les films protecteurs des adhésifs à l'arrière de la platine amovible

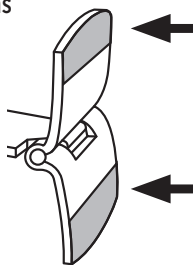

4 Fixer le store sur les supports GEKO

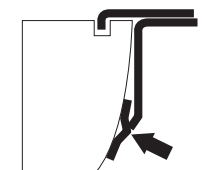
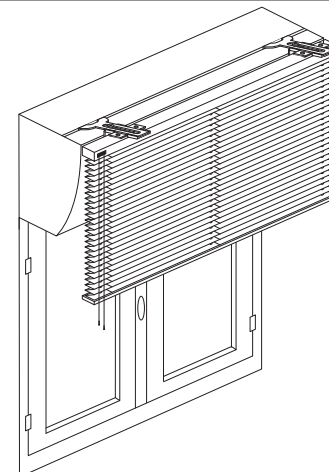
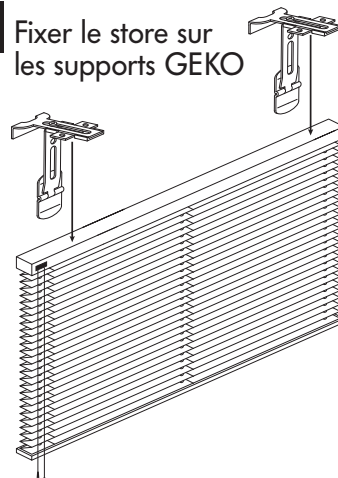

Positionner les supports GEKO dans la rainure et appuyer sur les platines amovibles.